



TRIG-STAR

National Society of Professional Surveyors
21 Byte Court, Suite H, Frederick, MD 21702
Phone: 240-439-4615 | Fax: 240-439-4952 | trig-star.com

Trig-Star is an annual High School Mathematics Competition sponsored by the National Society of Professional Surveyors and you, the local sponsor. The goal is to recognize and challenge the best students of mathematics from among school districts across the United States utilizing a competition with awards. The purpose of the Trig-Star program is:

- To build an awareness of land surveying as a profession among high school students, career guidance counselors, and high school teachers.
- To acquaint high school students with the use and practical applications of mathematics in the land surveying profession.
- To promote real world applications of mathematics in high school.
- To honor high school students who have demonstrated their superior skill among classmates at the local, state, and national levels.

Your assistance is critical to ensuring the success of the Trig-Star program. Trig-Star can be a tremendous public relations event for the land surveying profession. High school students, their parents, teachers, and the public see first-hand some of the work undertaken by land surveying professionals, and the concern of the profession for rewarding academic achievement and teaching excellence. Thank you for taking the time to become a Trig-Star sponsor.

The Trig-Star Competition can be a good way to introduce high school students to available land surveying college degree programs. Please encourage those students who may have an interest to check the box on the test cover form for more information. Checked Cover Sheets can be sent to info@nsp.us.com, and information will be sent to the student.

Trig-Star Competition results must be submitted to the State Trig-Star Coordinator and through the online form at trig-star.com – Submit Results

Please review the enclosed material carefully. Each state is responsible for running its own State Trig-Star competition in order to choose a State Trig-Star Champion who will compete in the National Trig-Star competition. Please contact the State Trig-Star Coordinator or Area Coordinator about the program in your state. A list of coordinators is available on trig-star.com. In addition to any awards at the local and state level, the State Trig-Star Champion will be eligible to compete for \$2,000, \$1000, and \$500 national prizes. The Teaching Excellence Awards also provide cash awards for the teachers of the national winners.

With your assistance we can maximize the exposure of the land surveying profession to the next generation and create a strong positive image of our profession. The Trig-Star endowment fund was created to ensure the future of our scholarship program and provide increased benefits. More information about the fund and Trig-Star can be found at trig-star.com. Thank you for your assistance and support of the Trig-Star Program.

Gerald Juarez, NSPS Trig-Star Chairperson



TRIG-STAR

2022-2023 Competition Packet



NSPS

**National Society of Professional Surveyors
240-439-4615 | trig-star.com**

CONTENTS

PREPARATION FOR THE LOCAL COMPETITION.....	1
LOCAL COMPETITION RULES.....	3
CALCULATOR POLICY	4
IN PERSON	5
ADMINISTRATION OF TEST	5
GRADING AND SCORING OF TEST	6
REPORTING	6
RESOURCES.....	6
ON-LINE	7
ADMINISTRATION OF TEST	7
GRADING AND SCORING OF TEST	8
REPORTING	8
RESOURCES.....	9
AWARDS & TESTING DATES.....	10
LOCAL CONTEST – LEVEL 1	10
STATE WINNER NOTIFICATION.....	10
NATIONAL COMPETITION – LEVEL 2	10
LOCAL COMPETITION REPORT	11
STATE COMPETITION REPORT	12
STATE WINNER STUDENT BIO FORM	15
CERTIFICATE OF PARTICIPATION.....	17
SPONSORSHIP AND AWARD ORDER FORM.....	18
SAMPLE TEST	19



PREPARATION FOR THE LOCAL COMPETITION

Contacting Your Local High School

Making first contact with the High School is often the hardest thing to do when trying to get a Trig-Star Program started. Here are some tips:

- Do you know a teacher, guidance counselor or administrator at your local high school that could introduce you to a math teacher?
- Do any of your children, grandchildren, nieces, nephews, etc., attend a nearby high school where you would be willing to visit to present the Trig-Star competition/test?
- Are there any neighbors, friends, church or social groups, teachers or school employees, or fellow employees who may be able to steer you in the right direction to contact the trigonometry teacher or math department head?
- Find out when a teacher is available and make your contact at that time, don't wait for them to call you.

Presentation Suggestions

One of the most important parts of the Trig Star Program is your initial presentation. The objective is to discuss careers in Land Surveying with the students. Tell them briefly, what it is, why it's a good career, why we like it and how trigonometry is used in our business as a practical application of math.

There are many Trig-Star presentation formats that can be followed. The variations depend not only on your personal speaking style, but also other factors, such as the size of the group you will be talking to, the amount of time allowed for your presentation and the room configuration that you will be presenting in. For example, small groups allow for more hands-on demonstration of equipment and explanation of Survey Plats or Maps. Questions are more common in small groups and personal connections are easier to make.

On the other hand, larger groups will allow you to reach more students and you may feel that you have made more efficient use of your time. Visual aids and demonstrations make for a better presentation. If you are going to do the competition online with remote students, try to work with the teacher to present your information to the group in an online setting.

Examples of Visual Aids and Demonstrations:

- Plats and Maps are always interesting to students, especially if it shows an area they are familiar with.
- Setting up a total station, using a drone, or demonstrating other survey technologies can encourage questions.
- Showing the types of data that is being captured and how it's being used can create discussions.
- Use of 3D/4D imagery from scans can also be a crowd pleaser.

If you can engage the students in doing some sample calculations, they feel more involved. For example, set up the total station in the classroom, a prism in the back of the room and another prism out the door in the hallway, if possible. Then measure the two distances and the interior angle between the lines. Sketch the measurements on the board and ask the students to solve for the unknown distance through the wall. If they seem unsure on how to approach the problem help them determine that they must use the law of cosines and fill out the equation on the board, then all students can perform the calculations on their calculators and come up with an answer.

It is also important to discuss what they should know to prepare for the Trig-Star Competition, such as:

- Use of basic trigonometric functions (sine, cosine, tangent).
- Use of basic trigonometric formulas (law of sine, law of cosine, Pythagorean theorem) and their applications.
- *Understanding and importance of rounding.*
 - Distances are rounded to the hundredth for the final answer only. Intermediate solutions for additional calculations should not be rounded, only the final answer. This may cause rounding errors.
 - Angles are rounded to the second and shown as degrees, minutes, and seconds, (DMS) for the final answers.
 - Areas are rounded to the nearest whole unit.
- Use of notes and reference books are NOT allowed. A basic formula sheet will be provided.
- Calculators are permitted for testing. However, programmable calculators are banned from being used. Graphing calculators are considered to be programmable calculators, which are only allowed if they are administered by the school and the teacher has verified that the programs have been cleared prior to testing. Please review current [Trig-Star Calculator Policy](#).

Resources

[BEaSURVEYOR.com](#): Website sponsored by National Society of Professional Surveyors (NSPS), providing information and resources relating to the profession of land surveying, including types, education, licensing, state societies and affiliations, and more.

[GetKidsIntoSurvey.com](#): A resource of fun and interactive activities for the land survey community to share the profession with children. (Free posters available)

[NCEES Speaker's Kit](#): A speaker's kit created by the National Council of Examiners for Engineering and Surveying (NCEES), which includes a Speakers Guide, PowerPoint presentation, script, and videos to help present the value of licensure.

[Trig-Star.com](#): Additional Trig-Star resources and support items



LOCAL COMPETITION RULES

1. Only one Trig-Star competition is allowed per high school per year. The winner will be designated the Trig-Star Champion for that particular school year.
2. All competitors in a particular high school must begin the Trig-Star test at the same time.
3. The winner is the student with the highest score in the fastest time. In the event of a tie, the fastest time will determine the winner.
4. The competition incorporates the use of complex trigonometric functions including right triangle formulas, circle formulas, the law of sines, and the law of cosines to solve real problems typically encountered in the surveying and mapping professions.
5. The competition is sanctioned nationally by the National Society of Professional Surveyors and State Surveying Societies, Affiliates, and Associations. The local sponsor is responsible for all competition fees, local promotion, news coverage, and presentation of local awards.
6. There shall be no cost to the competitor for the privilege of competing for the award designation Trig-Star. All Trig-Star competitors are eligible to apply to NSPS for the Trig-Star Scholarship.
7. Calculators are permitted for testing. However, programmable calculators are banned from being used. Graphing calculators are considered to be programmable calculators, which are only allowed if they are administered by the school and the teacher has verified that the programs have been cleared prior to testing. Please review current [Trig-Star Calculator Policy](#).
8. Notes and reference books are NOT allowed. A basic formula sheet is provided or included with the online test package.
9. The maximum time allowed to complete the test is 60 minutes.

Proper reporting of test results must be provided to the State Trig-Star Coordinator for the competition winner to be eligible for the State or National Competition. Similar reporting should be provided to NSPS through the "Submit Results" portal on the Trig-Star website: trig-star.com.



CALCULATOR POLICY

Calculators are permitted for testing. However, programmable calculators are banned from being used. Graphing calculators are considered to be programmable calculators, which are only allowed if they are administered by the school and the teacher has verified that the programs have been cleared prior to testing.



ADMINISTRATION OF THE LOCAL COMPETITION IN PERSON

The following instructions are to be used for the traditional in-person testing, utilizing a “paper” test. Prior to testing, the school sponsor should:

- Verify with NSPS, State Sponsor, or Local Sponsor that Trig-Star test license has been obtained. If the school is working under a state license, you should work with the State Coordinator to ensure that test is available for the current year.
- Choose a test date that is convenient for the school and any additional volunteers/proctors that may be assisting on-site.
- Work with the school to establish a timeline for results, acknowledgment, and awards. It is the responsibility of the local and State sponsors to provide results, acknowledgment, and awards for their level of the contest. For test security, the actual test shall not be returned to the teacher or the students.

ADMINISTRATION OF TEST

1. Work with school to secure a room for testing and provide an initial count of competitors.
2. Have enough copies of test available for distribution and secure a timer (stopwatch, phone, etc.) for timing the competitors.
3. Obtain the help of additional proctors as needed to assist you with monitoring the competitors as they complete the test. (Larger groups of competitors may require additional proctors.) Teachers usually can fill this role.
4. Calculators are permitted for testing. However, programmable calculators are banned from being used. Graphing calculators are considered to be programmable calculators, which are only allowed if they are administered by the school and the teacher has verified that the programs have been cleared prior to testing. Please review current [Trig-Star Calculator Policy](#).
5. Notes and reference books are NOT allowed. A basic formula sheet will be provided.
6. Competitors should be seated far enough apart to maintain test security.
7. Proctors may distribute tests while initial instructions are being read from the test cover sheet. Competitors may fill in the questions on the test cover sheet at this time but should be instructed NOT to open the test materials until told to do so.
 - a. The maximum time allowed to complete the test is 60 minutes.
 - b. Place answers in the spaces provided – answers shown elsewhere will not count. Be sure to give answers in the format requested.
 - c. All competition materials will be collected when you are finished.
 - d. Raise both hands when you finish – your time will be noted to the nearest second. (Accommodations should be made, if needed).

- e. After your test is collected, you may leave the room, unless instructed otherwise. (Check with school for appropriate instructions).
 - f. The winner is the student with the highest score in the fastest time.
8. Instruct the competitors to open the test materials, print their name in the space provided on the first page and begin.
 9. Start the timer.
 10. As the competitors finish, record their time to the nearest second on the test cover sheet and collect the test and any other test materials (scratch paper, etc.).
 11. After 60 minutes, collect all tests that have not been turned in and record a time of 60 minutes.

GRADING AND SCORING OF TEST

If you are giving the test by yourself, you may find it easier to take all the tests home and score them at a later time. If there are two or more of you giving the test, while one person is keeping the official time (collecting completed tests and marking the times on them); the other person could be scoring the tests.

The winner is the student with the highest score in the fastest time. In the event of a tie, the fastest time will determine the winner.

Students naturally want to know how they did on the test, even if they didn't come out on top. For the security of the test, copies of the tests shall not be given back to the students and teachers.

REPORTING

It is important to report test results of each participating high school to both the State Trig-Star Coordinator and NSPS to ensure that competitors have the opportunity for future scholarships. The following information should be provided to the State Coordinator, which may be used to determine the overall State Winner:

- Local Competition Report Form
- Copy of first place winner test (paper)
- List of student competitors (name and current grade), excel spreadsheet preferred

Similarly, the above information should be provided to NSPS through the "Submit Results" portal on the Trig-Star website: trig-star.com.

RESOURCES

The following forms and information can be found under Resources at trig-star.com:

- Calculator Policy
- Participation Certificate (downloadable)
- Trig-Star Medals (\$6 each) – 1st, 2nd, and 3rd Place available.
- Trig-Star Plaques (\$20 each) – Sponsor is responsible for engraving plaque with the winning student's name, high school, and year of the award. Plaque has room to include Sponsor's name.
- Yearly Scholarship Application
- Photo Release Form
- Sample Press Release



ADMINISTRATION OF THE LOCAL COMPETITION ON-LINE

The following instructions are to be used for online testing, when the students are gathered in-person at one location. If, due to restrictions, this is not possible or the only way to administer the test is all of the students are participating remotely, then special arrangements with the State Trig-Star Coordinator (in consultation with NSPS) will need to be made. Prior to testing, the school sponsor should:

- Verify with NSPS, State Sponsor, or Local Sponsor that Trig-Star test license has been obtained. If the school is working under a state license, you should work with the State Coordinator to ensure that test is available for the current year.
- Choose a test date and time that is convenient for the school.
- Reach out to State Coordinator and/or NSPS to obtain a unique link to access the online test. Information required to receive a link includes:
 - School Name (City and State)
 - Sponsor (contact info)
 - Date of test
 - Time of test. Due to the nature of the online testing platform, the link will be available 30 minutes prior to start and 30 minutes after assumed end to account for connectivity issues that may arise. The competitors will be allowed 60 minutes to complete the test.
- Work with the school to establish a timeline for results, acknowledgment, and awards. It is the responsibility of the local sponsor and State Coordinator to provide results, acknowledgment, and awards for their level of the competition.

ADMINISTRATION OF TEST

1. Work with the school to ensure that all computers used for testing have access to the internet. Additional proctors may be needed to assist you with monitoring the competition if the online testing is held in an in-person setting with multiple locations such as additional classrooms or computer labs. Teachers usually can fill this role.
2. The Sponsor will receive a school specific link that will be activated for the date and time previously requested. This information should be shared with the teacher who will pass it on to the students.
3. The following rules and instructions should be read to students prior to accessing the link:
 - a. You will be given 60 minutes to complete the test.
 - b. Calculators are permitted for testing. However, programmable calculators are banned from being used. Graphing calculators are considered to be programmable calculators, which are only allowed if they are administered by the school and the teacher has verified that the programs have been cleared prior to testing. Please review current [Trig-Star Calculator Policy](#).
 - c. No software programs other than those required for the online testing may be used while taking the test.

- d. Notes and reference books are NOT allowed. A basic formula sheet will be provided electronically with test link.
 - e. Answers must be in the format requested.
 - f. You can click on image to increase its size.
 - g. The online platform will allow you to skip questions; and then go back. Not all questions need to be answered to submit the online test. Be sure to review your test prior to submitting.
 - h. A countdown clock will be shown during the test to assist you with time management.
 - i. Any technological issues should be reported immediately to your instructor. Reporting should include the date, time, and specifics of the occurrence.
 - j. After finishing the test, follow the instructions provided by the school / teacher.
 - k. The winner is the student with the highest score in the fastest time.
4. Instruct the students to log onto the online testing platform using the link provided.
 - a. Complete the student information and start your test. The timer will automatically start when the student starts the test.

GRADING AND SCORING OF TEST

Once testing is complete, the sponsor should request the online test results from their Local Sponsor, State Coordinator and/or NSPS, whoever is their main contact. The results will be sent in a spreadsheet format and should be reviewed and certified by the local sponsor prior to announcement of winners.

Certification of results include verification of test takers and review of answer formats. In some cases, students may have included additional carriage spaces or words that may not have been accepted by the online test platform. For example: *135-22- 06*, instead of *135-22-06* for an angular answer OR *321 square units*, instead of *321*. If you give a score sheet to the teacher, let them know about the scoring policy.

The winner is the student with the highest score in the fastest time. In the event of a tie, the fastest time will determine the winner.

Students naturally want to know how they did on the test. For test security, the actual test will not be published.

REPORTING

It is important to report test results of each participating high school to both the State Trig-Star Coordinator and NSPS to ensure that participants have the opportunity for future scholarships. The following information should be provided to the State Coordinator, which may be used to determine the overall State Winner:

- Local Contest Report Form
- Copy of first place winner test (online results that have been certified)
- List of student participants (name and current grade), excel spreadsheet preferred

Similarly, the above information should be provided to NSPS through the "Submit Results" portal on the Trig-Star website: trig-star.com.

RESOURCES

The following forms and information can be found under Resources at trig-star.com:

- Calculator Policy
- Participation Certificate (downloadable)
- Trig-Star Medals (\$6 each) – 1st, 2nd, and 3rd Place available.
- Trig-Star Plaques (\$20 each) – Sponsor is responsible for engraving plaque with the winning student's name, high school, and year of the award. Plaque has room to include Sponsor's name.
- Yearly Scholarship Application
- Photo Release Form
- Sample Press Release



TRIG-STAR COMPETITION AWARDS & TESTING DATES

LOCAL CONTEST – LEVEL 1

Local sponsors should work with the State Trig-Star Coordinator to ensure local testing is complete prior to the deadline to announce the State Trig-Star Champion. The following information should be provided to the State Trig-Star Coordinator, which may be used to determine the overall State winner:

- Local Contest Report Form
- Copy of first place winners test (paper), or online testing results
- List of student participants (name and current grade) – excel spreadsheet preferred

Similarly, the above information should be provided to NSPS through the “Submit Results” portal on the Trig-Star website: trig-star.com.

STATE WINNER NOTIFICATION

State Trig-Star Coordinators shall choose and submit the State Trig-Star winners to NSPS by **June 1**. The following information shall be provided to NSPS when submitting the State winner, prior to receiving the National Competition,

- State Report Form
 - Individual Local Contest Report Form(s)
- List of participating high schools
- Total number of Trig-Star Contest participants within the State
- Value and nature of any awards given at the local level and by the State Society / Association

NATIONAL COMPETITION – LEVEL 2

State Trig-Star winners are offered the opportunity to take part in the National test. The test administrators will receive the National Trig-Star test after submission of the State winner’s name and test administrators contact information to NSPS. Test should be administered in accordance with the instructions and returned to NSPS.

NATIONAL COMPETITION AWARDS

The National Trig-Star winners will receive \$2,000 for first place, \$1,000 for second place, and \$500 for third place, in addition to any awards at the state and local level. The math teacher of the Trig-Star winner will receive a Teacher Excellence Award in the amount of \$1,000 for first place, \$500 for second place, and \$250 for third place.



National Society of Professional Surveyors LOCAL COMPETITION REPORT

TRIG-STAR

The following items should be submitted to the State Trig-Star Coordinator for determination of the State Trig-Star Champion. The State Trig-Star Coordinator is responsible for selection of the State Trig-Star winner and communicating that information to NSPS for the National Trig-Star Competition.

- Local Competition Report Form
- Copy of 1st place winner test, unless test was taken on-line
- List of student competitors (name and current grade), excel spreadsheet preferred
- Test Cover Sheets of Students requesting additional information should be scanned and sent to info@nsps.us.com
- Sponsors should consider announcing the Local Trig-Star winner in the local news. Sample press release and photo release form are available at trig-star.com.

Submit Report to State Trig-Star Coordinator

High School Name _____ Phone _____

Address _____

City _____ State _____ Zip Code _____

Math Teacher's Full Name _____

Phone _____ Email _____

Sponsor's Name or Company _____

Address _____

City _____ State _____ Zip Code _____

Phone _____ Email _____

Date of Competition _____ **Number of Competitors** _____

Competition was: In Person Remote Test was: Traditional/Paper On-line

1st Place Winner Name _____ Graduation Year _____

Score _____ Time _____ Award Type/Amount _____

Home Address _____

City _____ State _____ Zip Code _____

Phone _____ Email _____

Parent/Guardian Name(s) _____

Phone _____ Email _____

2nd Place Winner Name _____ Graduation Year _____

Score _____ Time _____ Award Type/Amount _____

3rd Place Winner Name _____ Graduation Year _____

Score _____ Time _____ Award Type/Amount _____



STATE COMPETITION REPORT

The NSPS Trig-Star Committee establishes procedures for testing the State Trig-Star winners and choosing a National Trig-Star Champion from the submitted State Trig-Star winners.

State Competition Report Forms must be submitted to NSPS by June 1 to be eligible for the National Trig-Star Competition.

Information related to the National Trig-Star Competition will be emailed to the Test Administrator, as listed on the following State Competition Report Form. The Test Administrator is responsible for administering the National Trig-Star Competition test in accordance with the instructions provided with the National Trig-Star test information. The Test Administrator is also required to administer (in person) the test and verify the results.

The following items should be submitted to NSPS (info@nsp.us.com) prior to June 1:

- State Competition Report Form
- State Winner Student Bio Form
- State Winner Photo (digital format please)
- State Winner Photo Release Form
- Copies of ALL Local Competition Report packages including:
 - Local Competition Report
 - Copy of 1st place winner test, unless test was taken on-line
 - List of student competitors (name and current grade), excel spreadsheet preferred

State Trig-Star Coordinators should consider announcing the State Trig-Star winners in the local news and to their State Land Surveyor Chapters and Affiliates. Sample press release and photo release form are available at trig-star.com.



National Society of Professional Surveyors
240-439-4615 | trig-star.com



National Society of Professional Surveyors STATE COMPETITION REPORT

TRIG-STAR

State Coordinator Name _____

Address _____

City _____ State _____ Zip Code _____

Phone _____ Email _____

Test Administrator Name

(For National Competition) _____

Address _____

City _____ State _____ Zip Code _____

Phone _____ Email _____

Total Number of High Schools _____ **Total Number of Competitors** _____

Number of High Schools having In Person Competitions _____

Number of High Schools having Remote Competitions _____

Number of High Schools with Traditional/Paper Testing _____

Number of High Schools with On-line Testing _____

STATE WINNER INFORMATION

1st Place Winner Name _____ Graduation Year _____

Score _____ Time _____ Award Type/Amount _____

Home Address _____

City _____ State _____ Zip Code _____

Phone _____ Email _____

Parent/Guardian Name(s) _____

Phone _____ Email _____

High School Name _____ Phone _____

Address _____

City _____ State _____ Zip Code _____

Math Teacher's Full Name _____

Address _____

City _____ State _____ Zip Code _____

Phone _____ Email _____

2nd Place Winner Name _____ Graduation Year _____
Score _____ Time _____ Award Type/Amount _____
Home Address _____
City _____ State _____ Zip Code _____
Phone _____ Email _____
Parent/Guardian Name(s) _____
Phone _____ Email _____

High School Name _____ Phone _____
Address _____
City _____ State _____ Zip Code _____

Math Teacher's Full Name _____
Address _____
City _____ State _____ Zip Code _____
Phone _____ Email _____

3rd Place Winner Name _____ Graduation Year _____
Score _____ Time _____ Award Type/Amount _____
Home Address _____
City _____ State _____ Zip Code _____
Phone _____ Email _____
Parent/Guardian Name(s) _____
Phone _____ Email _____

High School Name _____ Phone _____
Address _____
City _____ State _____ Zip Code _____

Math Teacher's Full Name _____
Address _____
City _____ State _____ Zip Code _____

CERTIFICATION:

I hereby certify that the winners listed above are the winners of the State Trig-Star for the current school year.

_____ Date _____
State Trig-Star Coordinator



National Society of Professional Surveyors
STATE WINNER STUDENT BIO FORM

Name _____ Graduation Year _____

High School Name _____ Phone _____

City _____ State _____

1. Where were you born and raised?
2. How many times have you taken part in Trig-Star?
3. Prior to Trig-Star, did you know about careers in Land Surveying?
4. What have you learned from your experience with Trig-Star? What would you say to others about this program?

5. Briefly describe your interests and hobbies:

6. What are your plans after high school? (college/university, technical school, gap year, straight into an industry)

7. Who do you feel has been most influential in your life and why?



TRIG-STAR

PHOTO RELEASE FORM

I give permission to NSPS and Trig-Star to use and publish my photograph on our website and social media platforms without compensation

Name _____

Home Address _____

Phone _____ Email _____

Parent/Guardian Name(s) _____

Phone _____ Email _____

Signature _____ Date _____

(If the participant is a minor, signature of Parent or Guardian is necessary.)



NSPS

National Society of Professional Surveyors

240-439-4615 | trig-star.com

National Society of Professional Surveyors

CERTIFICATE OF PARTICIPATION

Is hereby presented to

In recognition of your participation in the

TRIG-STAR COMPETITION



Trigonometry Teacher

Local Sponsor





TRIG-STAR SPONSORSHIP AND AWARD ORDER FORM

TRIG-STAR

Mail to:

Name _____

Company _____

Address _____

City _____ State _____ Zip Code _____

Phone _____ Email _____

State Trig-Star Sponsorship Qty: _____ (@ \$550.00) \$ _____
(Unlimited participating high schools within State)

Local Trip-Star Sponsorship Qty: _____ (@ \$ 60.00) \$ _____
(Local Application Form must be submitted for each high school sponsored)

Plaque (\$20.00 each)* Qty: _____ (@ \$ 20.00) \$ _____

Participation Medals (\$8.00 each)*

1st Place Qty: _____ (@ \$ 8.00) \$ _____

2nd Place Qty: _____ (@ \$ 8.00) \$ _____

3rd Place Qty: _____ (@ \$ 8.00) \$ _____

TRIG-STAR ENDOWMENT FUND DONATION (501(c)(3)) \$ _____

* Prices include shipping & handling

Total:\$ _____

Payment Options:

Invoice/PO _____ Check Visa Mastercard AmEx Discover

Make checks payable to NSPS

Card Number _____ Expiration _____ Security Code _____

Name on Card _____

Billing Address _____

City _____ State _____ Zip Code _____

I authorize NSPS to charge the credit card listed above for agreed upon purchases.

Signature _____ Date _____

*Please contact NSPS if you would like permission to use the NSPS logo or Trig-Star logo
for your own local awards: info@nsps.us.com*



TRIG-STAR

SAMPLE TEST



NSPS

National Society of Professional Surveyors
240-439-4615 | trig-star.com

TRIG-STAR PROBLEM LOCAL COMPETITION

PRINT NAME: _____

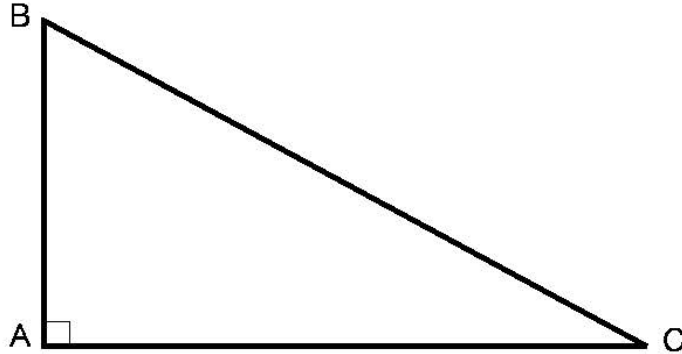

KNOWN: DISTANCE AB = 103.14 DISTANCE BC = 191.75

FIND: \angle CBA = _____ (5 POINTS)

DISTANCE AC = _____ (5 POINTS)

REQUIRED ANSWER FORMAT

DISTANCES: NEAREST HUNDREDTH
ANGLES: DEGREES-MINUTES-SECONDS
TO THE NEAREST SECOND

TRIG-STAR PROBLEM LOCAL COMPETITION

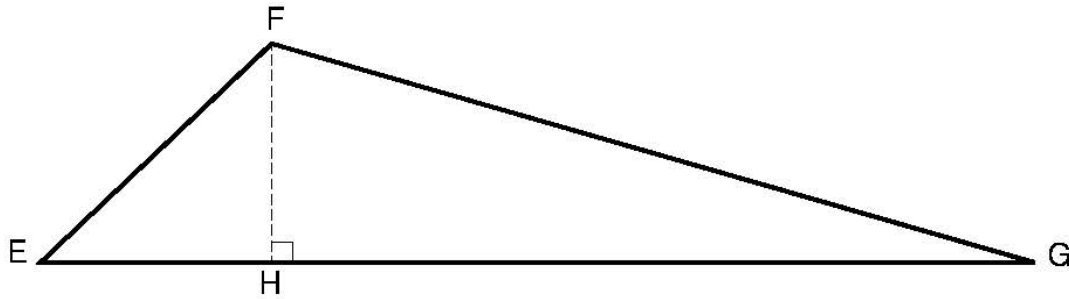

KNOWN: DISTANCE EF = 111.67 \angle EFG = $120^{\circ}13'57''$ \angle FEG = $42^{\circ}00'18''$

FIND: \angle EGF = _____ (6 POINTS)

DISTANCE EH = _____ (6 POINTS)

DISTANCE FH = _____ (6 POINTS)

DISTANCE FG = _____ (6 POINTS)

DISTANCE GH = _____ (6 POINTS)

REQUIRED ANSWER FORMAT

DISTANCES: NEAREST HUNDREDTH
ANGLES: DEGREES-MINUTES-SECONDS
TO THE NEAREST SECOND

PAGE TOTAL: _____ POINTS

TRIG-STAR PROBLEM LOCAL COMPETITION

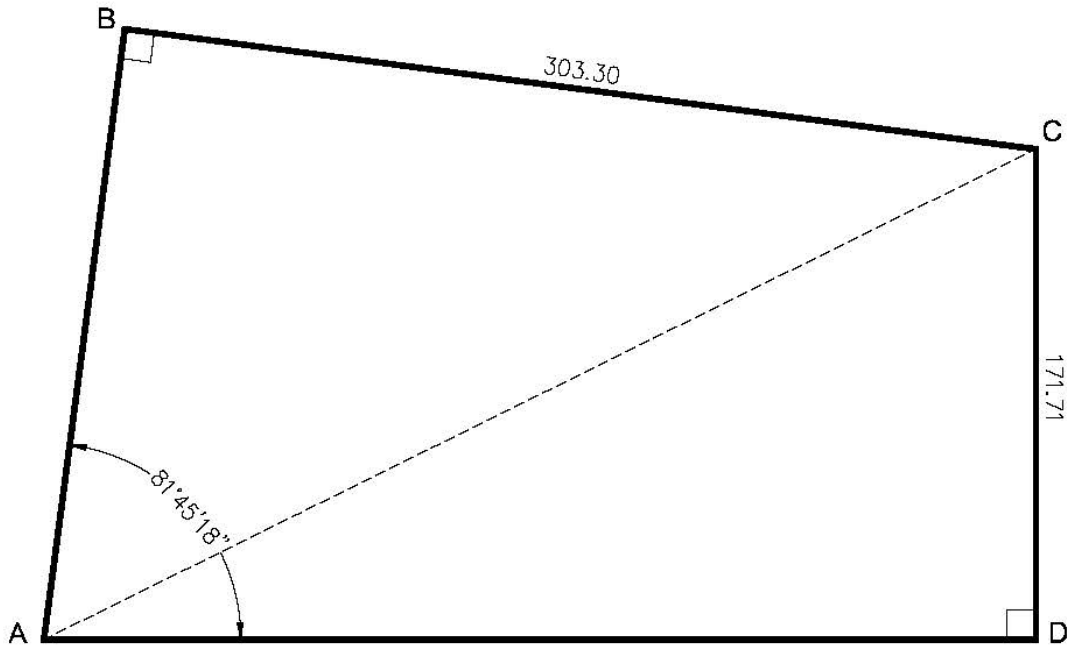

KNOWN: DISTANCE BC = 303.30 DISTANCE CD = 171.71
 \angle BAD = 81°45'18"

- FIND: DISTANCE AB = _____ (10 POINTS)
 DISTANCE AD = _____ (10 POINTS)
 DISTANCE AC = _____ (10 POINTS)

REQUIRED ANSWER FORMAT
 DISTANCES: NEAREST HUNDREDTH

PAGE TOTAL: _____ POINTS

TRIG-STAR PROBLEM LOCAL COMPETITION

A FATHER HAS DIVIDED A TRACT OF LAND AS SHOWN BY FIGURE A, B, C, D, AND ARC DA INTO LOTS FOR HIS THREE CHILDREN. THE TIME HAS COME FOR THE CHILDREN TO DETERMINE WHO GETS WHICH LOT. THEY DECIDE TO DRAW FROM A DECK OF CARDS FOR FIRST AND SECOND CHOICE. THE CHILDREN WOULD LIKE MORE INFORMATION BEFORE THEY MAKE THEIR CHOICES.

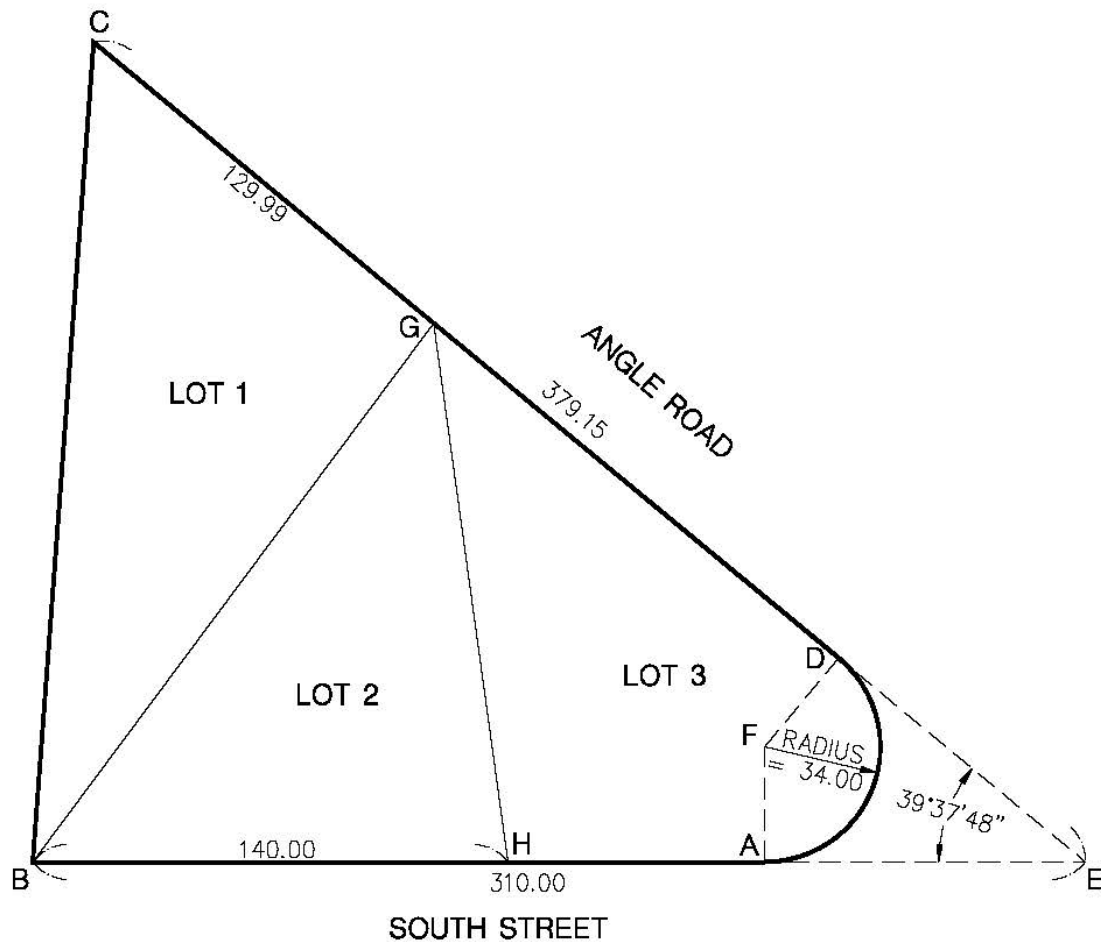

FIND:

DISTANCE BC = _____ (5 POINTS)

DISTANCE BG = _____ (5 POINTS)

DISTANCE GH = _____ (5 POINTS)

ARC DISTANCE AD = _____ (5 POINTS)

AREA LOT 1 = B,C,G,B = _____ (5 POINTS)

AREA LOT 3 = A,H,G,D, ARC DA = _____ (5 POINTS)

REQUIRED ANSWER FORMAT

DISTANCES: NEAREST HUNDREDTH
 AREA: NEAREST WHOLE UNIT

PAGE TOTAL: _____ POINTS

TRIG-STAR MISCELLANEOUS DATA

RIGHT TRIANGLE FORMULAS

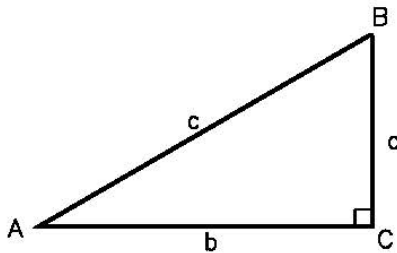

PYTHAGOREAN THEOREM: $a^2 + b^2 = c^2$

AREA: $\frac{1}{2}ab$

TRIGOMETRIC FUNCTIONS: $\sin A = \frac{a}{c}$ $\cos A = \frac{b}{c}$
 $\tan A = \frac{a}{b}$

OBLIQUE TRIANGLE FORMULAS

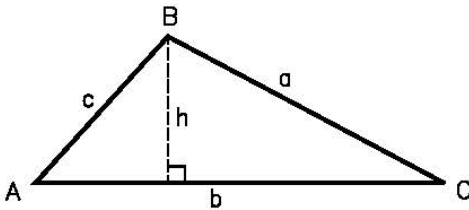

LAW OF SINES: $\frac{a}{\sin A} = \frac{b}{\sin B} = \frac{c}{\sin C}$

LAW OF COSINES: $a^2 = b^2 + c^2 - 2bc \cos A$

$$\cos A = \frac{b^2 + c^2 - a^2}{2bc}$$

AREA: $\frac{1}{2}bh$

CIRCLE FORMULAS

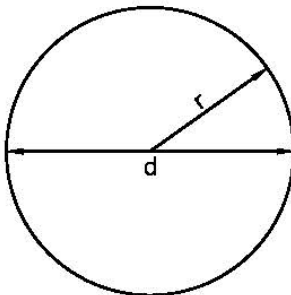

DIAMETER = d RADIUS = r

CIRCUMFERENCE: $2\pi r$ or πd

AREA: πr^2

ONE DEGREE (1°) OF ARC = 60 MINUTES (60') OF ARC

ONE MINUTE (1') OF ARC = 60 SECONDS (60'') OF ARC

THEREFORE ONE DEGREE OF ARC (1°) = 3600 SECONDS OF ARC.

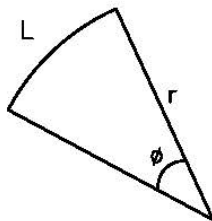

ARC LENGTH = $2\pi r\phi/360$

AREA: $\pi r^2(\phi/360)$

TRIG-STAR ANSWER KEY LOCAL COMPETITION

PAGE 1

$$\sphericalangle CBA = 57^{\circ}27'36''$$

$$\text{DISTANCE AC} = 161.65$$

PAGE 1

$$\sphericalangle EGF = 17^{\circ}45'45''$$

$$\text{DISTANCE EH} = 82.98$$

$$\text{DISTANCE FH} = 74.73$$

$$\text{DISTANCE FG} = 244.96$$

$$\text{DISTANCE GH} = 233.28$$

PAGE 2

$$\text{DISTANCE AB} = 217.45$$

$$\text{DISTANCE AD} = 331.35$$

$$\text{DISTANCE AC} = 373.20$$

PAGE 3

$$\text{DISTANCE BC} = 242.50$$

$$\text{DISTANCE BG} = 198.00$$

$$\text{DISTANCE GH} = 160.42$$

$$\text{ARC DISTANCE AD} = 83.30$$

$$\text{AREA OF LOT 1} = B,C,G,B = 12,851$$

$$\text{AREA OF LOT 3} = A,H,G,D,ARC DA = 11,716$$